

Chapter 2

Elements of Cellular Mobile Radio System Design

SOURCE:

MOBILE CELLULAR TELECOMMUNICATIONS

BY WILLIAM C.Y. LEE

General Description of the Problem

- Aim – efficient spectrum utilization
- Elements of Cellular Mobile Radio System Design
 - (1) the concept of frequency reuse channels
 - (2) the co-channel interference reduction factor
 - (3) the desired carrier-to-interference ratio
 - (4) the handoff mechanism
 - (5) cell splitting.
- Challenge - to serve the greatest number of customers with a specified system quality

- 1. How many customers can we serve in a busy hour?
- 2. How many subscribers can we take into our system?
- 3. How many frequency channels do we need?

Maximum Number of Calls Per Hour Per Cell

- The size of the cell
- The traffic conditions in the cell

Maximum Number of Frequency Channels Per Cell

- Average calling time in the system
- Charging rate of the system
- The general income profile of the users

- **Offered load = $A = Q_i * T$ (hours) erlangs**
- average calling time - T
- maximum calls per hour per cell - Q_i

- Let the maximum calls per hour Q_i in one cell be 3000 and an average calling time T be 1.76 min. The blocking probability B is 2 percent.
- Find the offered load and number of channels.

Concept of Frequency Reuse Channels

- In this frequency reuse system, users in different geographic locations (different cells) may simultaneously use the same frequency

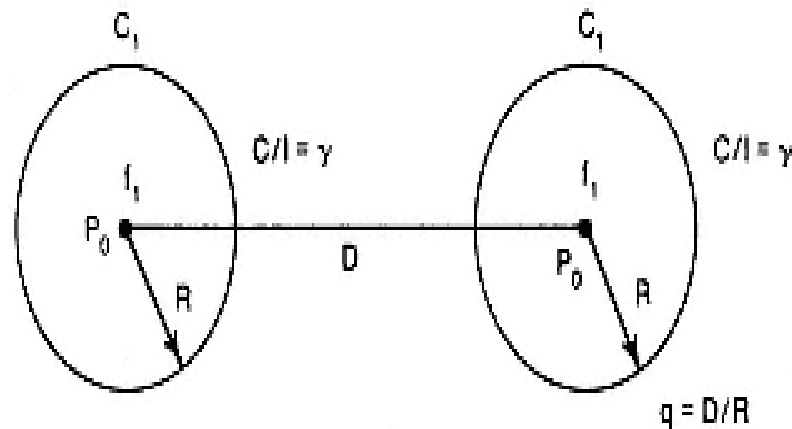

- increase the spectrum efficiency
- Interference due to the common use of the same channel is called *cochannel interference*

Frequency Reuse Schemes

- Frequency reuse in the time domain results in the occupation of the same frequency in different time slots
- Frequency reuse in the space domain
 - 1. Same frequency assigned in two different geographic areas, such as AM or FM radio stations using the same frequency in different cities.
 - 2. Same frequency repeatedly used in a same general area in one system the scheme is used in cellular systems.

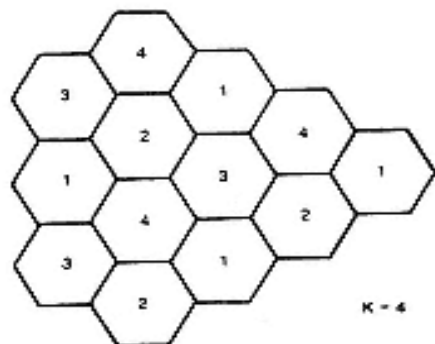

$K = 4$

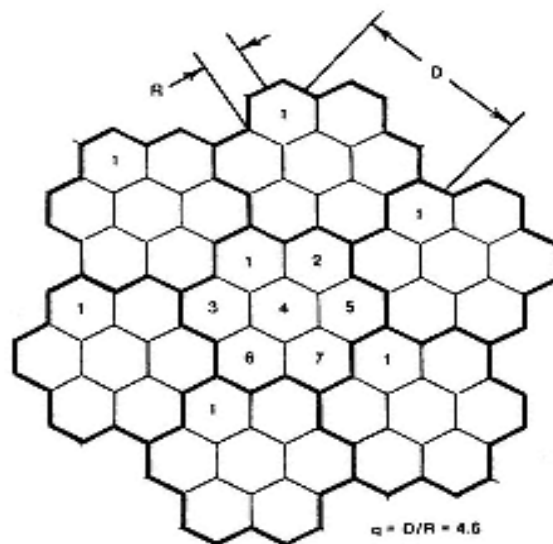

$q = D/R = 4.6$
 $K = 7$

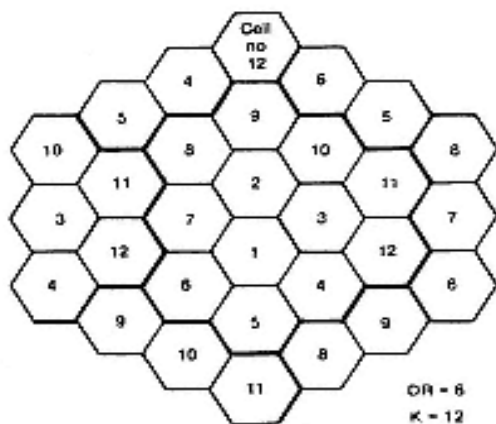

$OR = 6$
 $K = 12$

12 Cell reuse pattern to start-up configuration

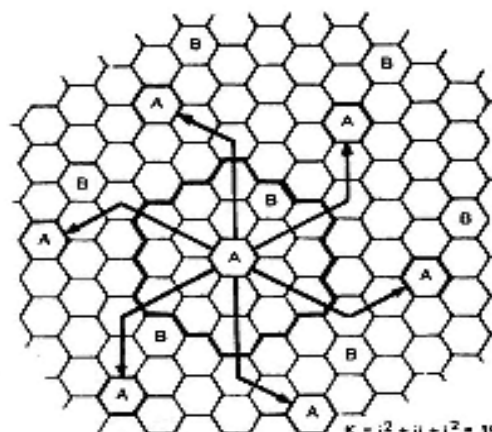

$K = i^2 + j^2 = 19$

Shift parameters $i = 3, j = 2$

$$D = \sqrt{3K} R \quad (2.2-1)$$

$$D = \begin{cases} 3.46R & K = 4 \\ 4.6R & K = 7 \\ 6R & K = 12 \\ 7.55R & K = 19 \end{cases}$$

Handoff mechanism

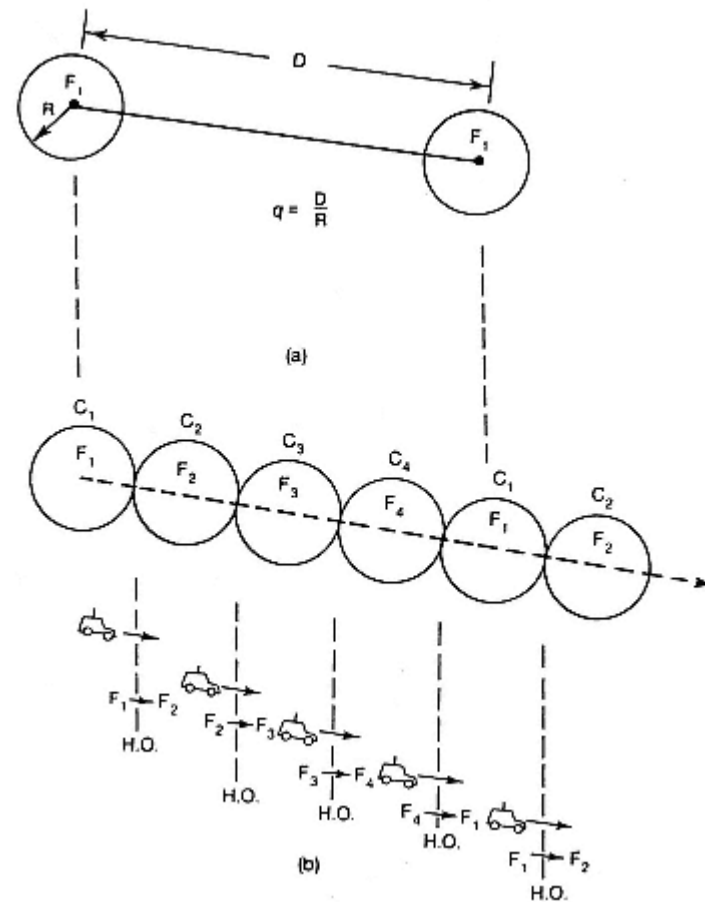

Cell splitting

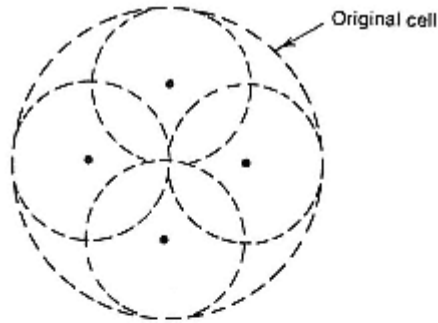

(a)

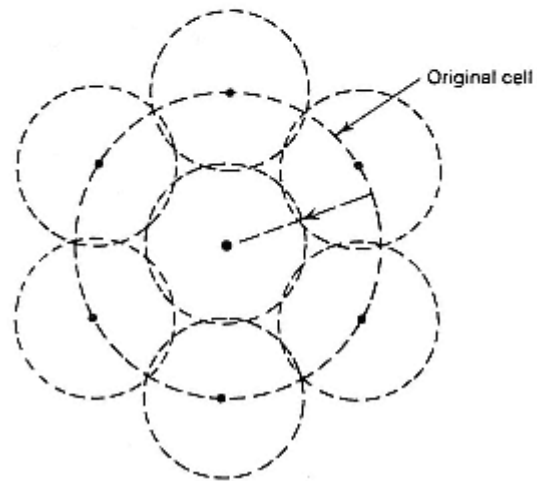

(b)

Consideration of the Components of Cellular Systems

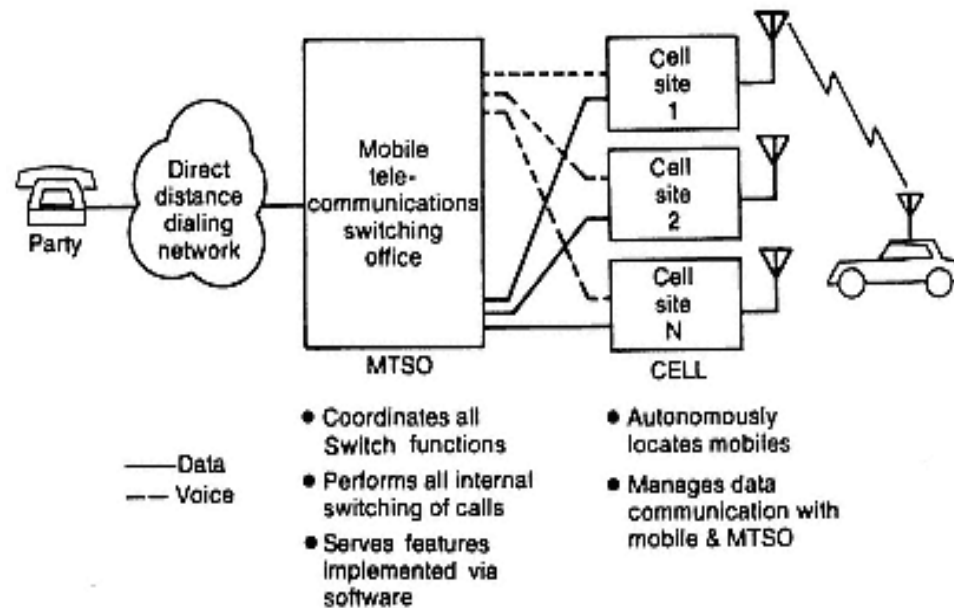

Cochannel Interference Reduction Factor

- $q = D/R$
- $D = f(K_I, C/I)$
- where K_I is the number of cochannel interfering cells in the first tier and
- C/I is the received carrier-to-interference ratio at the desired mobile receiver

$$\frac{C}{I} = \frac{C}{\sum_{k=1}^{K_I} I_k} \quad (2.3-3)$$

$$\frac{C}{I} = \frac{R^{-\gamma}}{\sum_{k=1}^{K_I} D_k^{-\gamma}} \quad (2.3-4)$$

$$\frac{C}{I} = \frac{1}{\sum_{k=1}^{K_I} \left(\frac{D_k}{R}\right)^{-\gamma}} = \frac{1}{\sum_{k=1}^{K_I} (q_k)^{-\gamma}} \quad (2.3-5)$$

$$q_k = \frac{D_k}{R} \quad (2.3-6)$$

where q_k is the cochannel interference reduction factor with k th cochannel interfering cell

$$\frac{C}{I} = \frac{R^{-\gamma}}{6D^{-\gamma}} = \frac{q^\gamma}{6} \quad (2.4-1)$$

Thus

$$q^\gamma = 6 \frac{C}{I} \quad (2.4-2)$$

- The propagation path loss is 40dB/dec
- Hence,
- $q = (6 * C/I)^{1/6}$
- $= (6 * 63.1)^{1/6} = 4.41$
- $C/I = 18\text{dB}$ is measured by the acceptance of voice quality from the present receivers.

The maximum number of K_i in the first tier can be shown as six (i.e., $2\pi D/D \gg 6$).

